

Control Unit and Cables EVC-C2 D11A-A, D11A-B, D11A-C, D11A-D MP

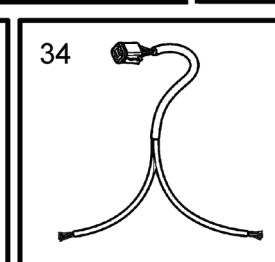
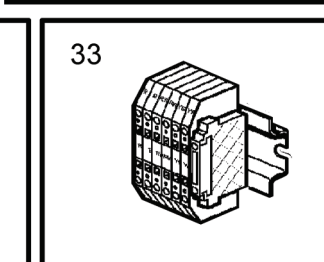
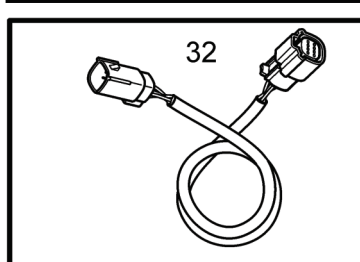
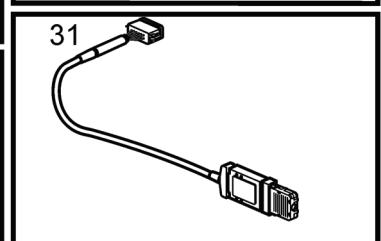
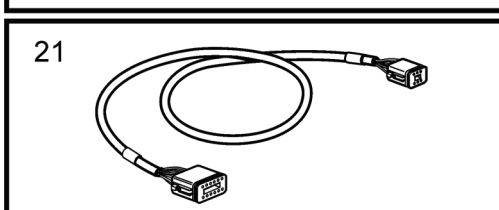
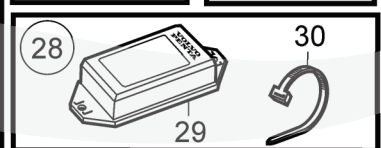
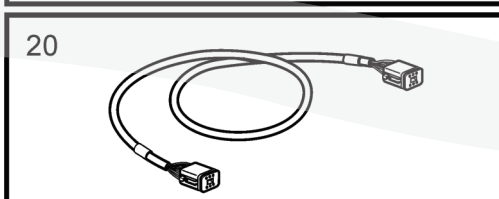
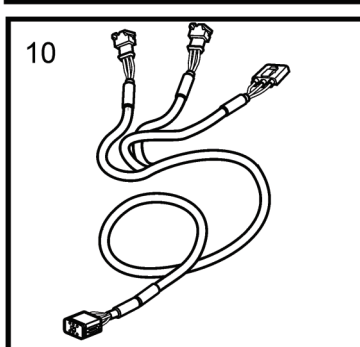
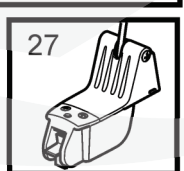
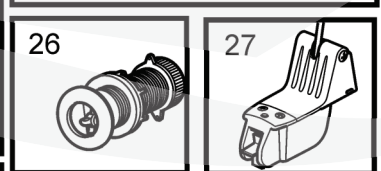
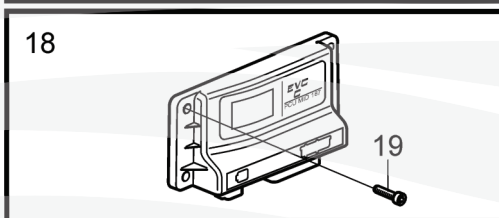
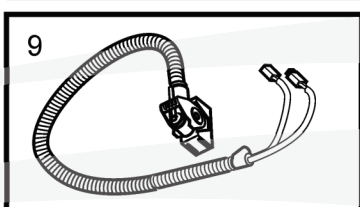
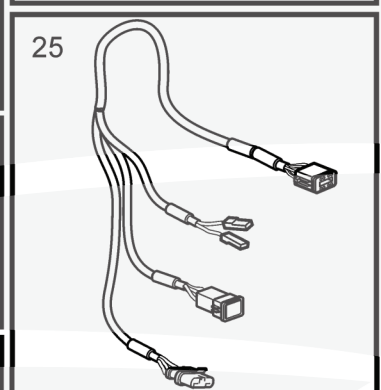
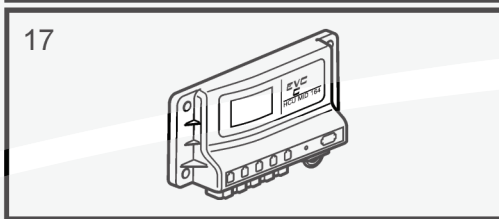
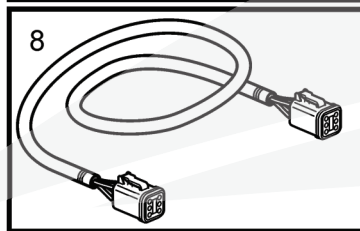
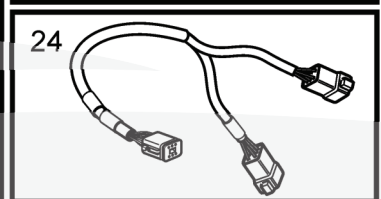
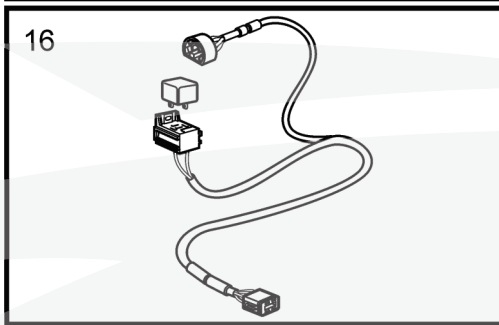
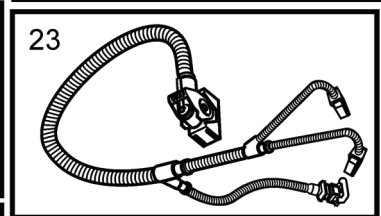
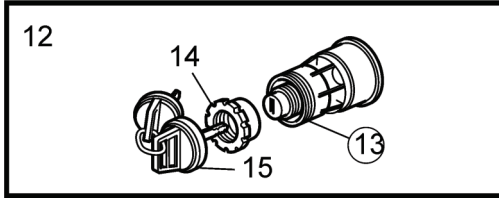
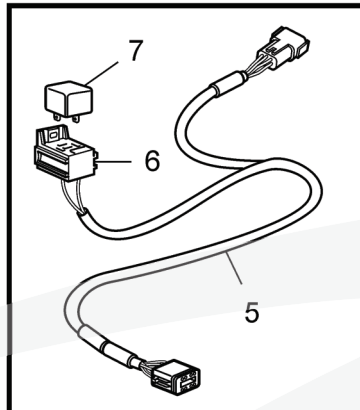
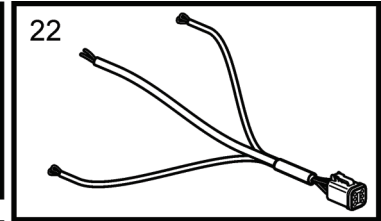
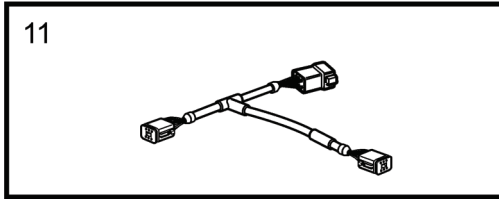
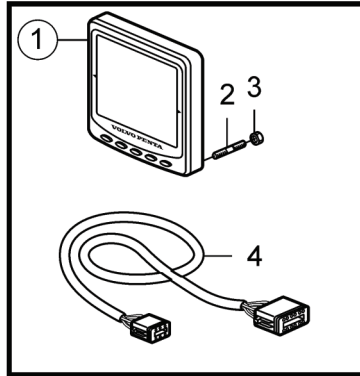

REF	PART NO.	QTY	DESCRIPTION
1	21173162	1	Display
2	830928	4	Stud
3	830930	4	Wing nut
4	3588207	1	Cable kit
5	881786	1	Cable kit
6	977184	1	Housing
7	873765	1	Relay 12V
7	3171420	1	Relay 24V
8	3842733	1	Extension cable L=3.0m
8	3842734	1	Extension cable L=5.0m
8	3842735	1	Extension cable L=7.0m
8	3842736	1	Extension cable L=9.0m
8	3842737	1	Extension cable L=11.0m
8	21172469	1	Extension cable L=20.0m
8	21172470	1	Extension cable L=40.0m, Replaced by 22815614
8	22815614	1	Cable kit, 100 m Data link cable kit, Type Approved 100m
8	22815615	1	Cable kit, 1000 m Data link cable kit, Type Approved 1000m
8	22815617	1	Cable kit, 25 m Data link cable kit, Type Approved 25m
8	874789	1	Cable kit PCU-HCU, 6 pole, L=5.0m
8	889550	1	Cable PCU-HCU, 6 pole, L=7.0m
8	889551	1	Cable PCU-HCU, 6 pole, L=9.0m
8	889552	1	Cable PCU-HCU, 6 pole, L=11.0m
8	888013	1	Cable PCU-HCU, 6 pole, L=13.0m
9	40005754	1	Wiring harness Engine-PCU cable., L=2.65m
10	874676	1	Cable kit EVC control lever cable, 6-pole., L=1.5m
11	3588972	1	Cable kit T-connector bus cable, 6-pole., L=0.5m
12	3587070	1	Starter switch, set Kit with 2 key switch with identical key
13	3587071	1	Starter switch
14	859955	1	Plastic nut
15	859953	1	Key State key code when ordering
16	888004	1	Cable, starter switch
17	21339291	1	Control unit, not programmed HCU. Software ordered separately or downloaded with Vodia.
17	3586261	1	Software - Warehouse programming. This p/n can not be ordered, but will be used for invoicing.

REF	PART NO.	QTY	DESCRIPTION
17	3586259	1	Software - Vodia-programming. This p/n can not be ordered, but will be used for invoicing.
17	21172467	1	Control unit XCU
18	213393311	1	Control unit, not programmed PCU. Software ordered separately or downloaded with Vodia.
18	3586267	1	Software - Warehouse programming. This p/n can not be ordered, but will be used for invoicing.
18	3586266	1	Software - Vodia-programming. This p/n can not be ordered, but will be used for invoicing.
19	946934	4	Flange screw
20	3886666	1	Cable, synchronizing - Synchronizing cable for twin installation. 6 pole., L=1.5m
20	21166002	1	Wiring harness L=7m
20	21166003	1	Wiring harness L=9m
20	21166004	1	Wiring harness L=13m
21	3885343	1	Wiring harness - Triple and quadruple installation.
22	3807229	1	Wiring harness, fuel
23	40005753	1	Wiring harness
24	3588206	1	Cable kit, y-split - For connecting extra equipment to Multilink
25	3808852	1	Cable kit, instruments, panels
26	3587054	1	Sensor Through hull
27	3587055	1	Sensor Mounted on transom
28	21281264	1	Converter Obsolete part
29		1	Converter
30	948211	2	Cable tie
31	21509941	1	Control unit
32	22739429	1	Wiring harness - Cable, Single data link, 3m, Type Approved
32	22810677	1	Wiring harness - Cable, Single data link, 11m, Type Approved
32	23650460	1	Wiring harness - Cable, Single data link, 0,5m, Type Approved
33	22797159	1	Terminal block - Terminal block, Type Approved
34	22739427	1	Wiring harness - Y-split data link cable, Type Approved